



RADIAN®

PRODUCT GUIDE 2024

A MESSAGE TO OUR CUSTOMERS

Thank you for your continued support into 2024! As we continue to develop and deliver firearms products for the market in the new year, we want to say thank you for your business and support. In a market with near countless choices we understand that customer loyalty must be earned through a combination of quality, innovation, and service. All Radian products come with a Lifetime Warranty against manufacturer defects, even if you're not the original owner. Shoot with confidence – we'll be here if you need us.

Thank you again.
Sincerely,



JOSHUA UNDERWOOD
Founder & CEO





THE PISTOL EVOLVED™

AFTERBURNER™ + RAMJET™

▷ MICRO-COMPENSATOR + PORTED PISTOL BARREL

The Radian® AFTERBURNER™ + RAMJET™ combo provide industry leading recoil reduction and match grade accuracy in a concealed carry package. The threadless barrel design allows for effortless instal/removal for cleaning, while LEGAL FOR SALE IN ALL 50 STATES.

The AFTERBURNER™ compensator is machined from hardened stainless steel and the RAMJET™ barrel from hardened 416R SS; both are enhanced with a Radianite™ Black coating. This combination achieves low friction, high hardness, and high corrosion resistance, making overall durability and erosion from muzzle blast a non-issue. Angled front faces on the AFTERBURNER™ aid in holstering.

The INTRA-LOK® mounting system uses the taper lock principle; a tapered locking screw interfaces with an angled V-groove on the underside of the barrel. This perfectly times the compensator as it locks down onto the upper barrel profile on the muzzle end of the barrel.

INTRA-LOK® allows the user to simply slide the compensator over the barrel, insert and tighten the locking screw, making for a simple and repeatable installation process. This system allows the user to easily remove the barrel from the slide for cleaning.

PRODUCT FEATURES

- | | |
|--------------------------|-----------------------------------|
| AFTERBURNER™ Hardened SS | Loaded Chamber Indicator |
| RAMJET™ Hardened 416R SS | Available in Radianite Black |
| Match Grade Barrel | Additional color offerings in PVD |
| Gas Sealing Chamber | |



AFTERBURNER™ + RAMJET™

COMPATIBLE WITH:
GLOCK® G19™ GEN3®



AFTERBURNER™ + RAMJET™

COMPATIBLE WITH:
GLOCK® G19™ GEN4®



AFTERBURNER™ + RAMJET™

COMPATIBLE WITH:
GLOCK® G19™ GEN5®,
G45, & G19X



AFTERBURNER™ + RAMJET™

COMPATIBLE WITH:
GLOCK® G17™ GEN5®
& G47



AFTERBURNER™ + RAMJET™

COMPATIBLE WITH:
SIG SAUER® P365

COMPRESSOR™

QUICK-TUNE™ GUIDE ROD ASSEMBLY

Most adjustable guide rods on the market use a cap screw to retain the spring. The problem? Loose screws are too common and thread locker forces you to commit to one spring weight.

Enter the screwless design of the Radian® COMPRESSOR™ Quick-Tune™ Guide Rod. The dovetail interface is captured by the spring, creating a simple and secure lock-up. Flutes along the guide rod allow the spring to move with less friction for smoother cycling. The heat treated guide rod has a slick, durable, and corrosion-resistant Nitride finish.

SPECIFICATIONS

- Screwless Design
- 13, 15, 18LB Springs included



COMPATIBLE WITH:
GLOCK® G19™ GEN1-5®,
G19X™, & G45™

GUARDIAN™

▷ OPTIC MOUNT & GUARD

The Radian GUARDIAN Optic Mounting System is the most secure system on the market.

TRU-SEAL™ eliminates the need for an added sealing plate. Pre-installed O-rings on the mounting screws hold the plate watertight to the slide, sealing out moisture, eliminating corrosion in the mounting threads.

Our STUD-LOK™ threaded stud/nut mounting interface is the most secure system on the market. This provides much longer thread engagement, greater hold down power, with increased shear resistance.

MATERIALS

7075 Aluminum Type III Hard
Anodized Guard/Plate

Custom Machined SS Fasteners
with Oversized Torx Sockets

INCLUDES

2 - Plate Mounting Screws

2 - TRU-SEAL™ O-Rings

2 - STUD-LOK™ Studs

2 - STUD-LOK™ Self-Locking Sleeve Nuts

SIX™

▷ GUARDIAN INTEGRATED BACK-UP SIGHTS

SIX™ back-up sights (BUS) seamlessly integrate into the Guardian Optic Mounting System providing rapid, reliable, and precise target acquisition in scenarios of red dot optic malfunction. Featuring anti-glare, anti-snag and ultra low co-witness design, SIX™ sights lie inconspicuously in wait until you need to deploy them. Like a wingman when things aren't going as planned, SIX™ has your six.



GUARDIAN™ + SIX™

FOR GLOCK® MOS™ /
TRIJICON™ RMR™ (TYPE 1 & 2)



GUARDIAN™ + SIX™

FOR GLOCK® MOS™ /
HOLOSUN™ EPS™



GUARDIAN™ + SIX™

FOR WALTHER® PDP™ 2.0 /
TRIJICON™ RMR™ (TYPE 1 & 2)



GUARDIAN™ + SIX™

FOR WALTHER® PDP™ 2.0 /
HOLOSUN™ EPS



COMING 2024

GUARDIAN™ + SIX™

FOR GLOCK® MOS™ /
HOLOSUN™ 407/507C



COMING 2024

GUARDIAN™ + SIX™

FOR GLOCK® MOS™ /
HOLOSUN™ 507COMP



COMING 2024

GUARDIAN™ + SIX™

GLOCK® MOS™ /
TRIJICON™ RCR

COMING 2024

BACKSTRAP + MAGWELL

▷ X-MACRO GRIP MODULE

The Radian Backstrap + Magwell X-Macro Grip Module were designed in tandem to provide users with a major upgrade in ergonomics, providing a more secure grip on one of the most popular everyday-carry firearms on the market today – The Sig Sauer P365-XMACRO.

The P365-XMACRO Backstrap features aggressive and deep channels which maximize surface contact, and enhance overall grip, all while remaining forgiving on the hand. The palm swell allows for a repeatable connection resulting in more control of the firearm, leading to improved accuracy and quicker follow-up shots.

The front of the P365-XMACRO Magwell aids in keeping the fingers positioned high on the grip. The flared feed walls ensure reliable reloads even under stressful self-defense scenarios. The rear of the Magwell is heavily rounded to minimize biting into the palm while also providing a soft outline virtually eliminating printing while carrying concealed. The Magwell maintains compatibility with all OEM XMACRO magazine base pads.

The Radian P365-XMACRO Backstrap + Magwell is installed using a patent pending screwless design. The precision machined dovetail interface with spring-loaded retention stud secures the two components in place.

COMPATIBILITY

Sig Sauer® P365-XMACRO
Grip Module



MATERIALS

Aircraft Grade Aluminum
MIL-SPEC Type III Hard Anodized

INCLUDES

- 1 - Backstrap
- 1 - Magwell
- 1 - Retention Stud & Spring
- 1 - Retention Stud Tool

AVAILABLE COLORS

-  BLACK
-  GREY
-  BRONZE



COMING 2024

TRU-17™

▷ MAGAZINE BASE PAD

The TRU-17 Magazine Base Pad is a direct replacement part compatible with P365 XMACRO magazines. The design of the TRU-17 allows users to easily load the full 17 rounds into the magazine, which is an issue that some users experience with stock base pads. The TRU-17 base pad adds weight to the bottom of the magazine which aids in dropping empty magazines. A larger grip surface allows users to index spare magazines from holsters for quicker reloads while also being able to easily extract stuck magazines. Removal of the OEM base pad and installation of the TRU-17 Base Pad is simple using the magazine spring detent at the bottom of the magazine. The TRU-17 Magazine Base Pad is sold as a pack of two.



THE RIFLE EVOLVED™



RADIAN® MODEL 1™



ABOUT

The design philosophy behind the Radian® Model 1™ is simple: use the highest quality raw materials, most precise CNC machining equipment, and best components available to create a weapon that seamlessly blends form and function. Beyond quality and aesthetics, the Model 1 features fully ambidextrous controls, adding much-needed utility for both left and right handed shooters. Every Model 1 is assembled by hand, one at a time, by a trained gunsmith who inspects, test fires, and cleans the weapon to personally guarantee it meets the most rigid quality standards. No detail has gone overlooked, which is why the Model 1, like every Radian product, is guaranteed for life.

KEY FEATURES

- | | | | |
|------|---|------|--|
| 1 \ | Magpul® 6-Position MIL-SPEC Collapsible Stock | 11 \ | Right-Side Bolt Release |
| 2 \ | H2 Carbine Buffer | 12 \ | A-DAC™ Right-Side Mag. Release Button & Bolt Hold Open |
| 3 \ | Radian® Ultra-Light QD End Plate | 13 \ | Left-Side Mag. Release (<i>Other Side of Rifle</i>) |
| 4 \ | Radian® Raptor-SD™ Ambidextrous Charging Handle | 14 \ | ADAC-15™ Billet Machined 7075-T6 Lower Receiver |
| 5 \ | Magpul® Pistol Grip | 15 \ | Radian® Take-Down Pins |
| 6 \ | Radian® Lightweight Forward Assist | 16 \ | Proprietary Extended Hand Guard |
| 7 \ | Radian® Talon™ Ambidextrous 45°/90° Safety Selector | 17 \ | Match Grade 416R Stainless Steel Barrel |
| 8 \ | Billet Machined 7076-T6 Upper Receiver | 18 \ | Direct Impingement Gas System |
| 9 \ | Radian® Vertex™ Trigger | 19 \ | Magpul® M-LOK® Modular Mounting System |
| 10 \ | Enhanced Black Nitride M16 Bolt Carrier Group | 20 \ | Dead Air™ Key-Mo Flash Hider |

MODEL 1™ CONFIGURATIONS



MODEL 1™ | 9"
SBR or Pistol

- ▶ .300 Blackout
- ▶ 5/8x24 Thread Pitch
- ▶ Pistol-Length Gas System
- ▶ Magpul® Pistol Grip and Collapsible Stock



MODEL 1™ | 10.5"
SBR or Pistol

- ▶ .223 WYLDE
- ▶ 1/2x28 Thread Pitch
- ▶ Carbine-Length Gas System
- ▶ Magpul® Pistol Grip and Collapsible Stock



MODEL 1™ | 14.5"
Rifle

- ▶ .223 WYLDE
- ▶ 1/2x28 Thread Pitch
- ▶ Mid-Length Gas System
- ▶ Magpul® Pistol Grip and Collapsible Stock



MODEL 1™ | 16"
Rifle

- ▶ .223 WYLDE
- ▶ 1/2x28 Thread Pitch
- ▶ Mid-Length Gas System
- ▶ Magpul® Pistol Grip and Collapsible Stock



MODEL 1™ | 17.5"
Rifle

- ▶ .223 WYLDE
- ▶ 1/2x28 Thread Pitch
- ▶ Intermediate-Length Gas System
- ▶ Magpul® Pistol Grip and Collapsible Stock



MODEL 1™ CC | 14.5"
Rifle

- ▶ .223 WYLDE
- ▶ 1/2x28 Thread Pitch
- ▶ Mid-Length Gas System
- ▶ California Compliant Shark-Fin Pistol Grip
- ▶ Non-adjustable Magpul® Buttstock



MODEL 1™ CC | 16"
Rifle

- ▶ .223 WYLDE
- ▶ 1/2x28 Thread Pitch
- ▶ Mid-Length Gas System
- ▶ California Compliant Shark-Fin Pistol Grip
- ▶ Non-adjustable Magpul® Buttstock



MODEL 1™ CC | 17.5"
Rifle

- ▶ .223 WYLDE
- ▶ 1/2x28 Thread Pitch
- ▶ Intermediate-Length Gas System
- ▶ California Compliant Shark-Fin Pistol Grip
- ▶ Non-adjustable Magpul® Buttstock

AVAILABLE COLORS:



MODEL 1™ CALIFORNIA COMPLIANT CONFIGURATIONS

MODEL 1™ RIFLE SPECIFICATIONS

Designed & Manufactured in the USA

Upper Receiver, Lower Receiver, and Hand Guard Cerakoted together for perfect color match

Weight: 6.0 - 8.0 lbs Depending on Configuration

UPPER RECEIVER SPECIFICATIONS

Sub-MOA Accuracy Guarantee w/ Black Hills Match Grade Ammunition

Billet Machined 7075-T6 Upper Receiver w/ M4 Feed Ramps

Proprietary Extended Aluminum Hand Guard w/ Magpul M-LOK® Modular Mounting System and Integrated Upper/Hand Guard Hardened Steel Anti-Rotation Pin

Match Grade 416R Stainless Steel Barrel

Black Nitride M16 Enhanced Bolt Carrier Group

Ultra Lightweight 7075 Aluminum Forward Assist Assembly w/Titanium Pawl

Radian Raptor-SD Ambidextrous Charging Handle

Direct Impingement Gas System

Dead Air Muzzle Device

LOWER RECEIVER SPECIFICATIONS

Billet Machined 7075-T6 Lower Receiver w/ Integral Trigger Guard and Flared Magazine Well

A-DAC™ Ambidextrous Dual-Action Catch Right Side Bolt Hold Open Feature

Ambidextrous Right & Left Side Magazine and Bolt Release Buttons

Radian Talon™ Modular Ambidextrous 45°/90° Safety Selector



RECEIVERS

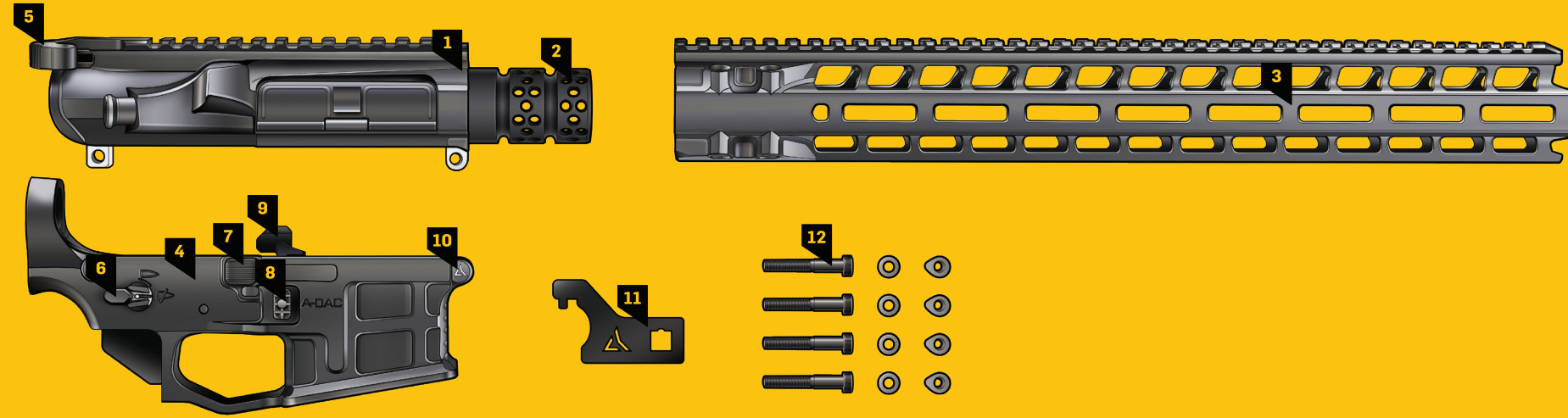

MODEL 1™ BUILDER KIT

INCLUDES

- | | | |
|---|---|---|
| 1 \ Billet Upper Receiver w/Dust Cover, Anti-Rotation Pin & Light Weight Forward Assist Installed | 7 \ Right Side Bolt Release | Left Hand Magazine Release Lever <i>(Other Side of Rifle)</i> |
| 2 \ Barrel Nut | 8 \ A-DAC capable magazine release / bolt hold open | Magazine Catch <i>(Other Side of Rifle)</i> |
| 3 \ Hand Guard w/Magpul® M-LOK® Modular Attachment Interface | 9 \ Radian® Extended bolt catch | Anti Rotation Hammer Pin <i>(Other Side of Rifle)</i> |
| 4 \ Radian® ADAC-15™ Lower Receiver | 10 \ Enhanced Takedown Pin Set | |
| 5 \ Radian® Raptor-SD™ Ambidextrous Charging Handle | 11 \ Barrel Nut Wrench | |
| 6 \ Radian® Talon™ 45°/90° Ambidextrous Safety Selector | 12 \ T30 Torx for Hand Guard Bolts | |

BUILDER KIT CONFIGURATIONS



BUILDER KIT | 8.5"
ADAC-15™ LOWER,
BILLET UPPER &
M-LOK® HAND GUARD



BUILDER KIT | 10"
ADAC-15™ LOWER,
BILLET UPPER &
M-LOK® HAND GUARD



BUILDER KIT | 14"
ADAC-15™ LOWER,
BILLET UPPER & M-LOK®
HAND GUARD



BUILDER KIT | 15.5"
ADAC-15™ LOWER,
BILLET UPPER & M-LOK®
HAND GUARD



BUILDER KIT | 17"
ADAC-15™ LOWER,
BILLET UPPER &
M-LOK® HAND GUARD

AVAILABLE COLORS:

- | | | | | |
|--|--|---|---|---|
|  RADIAN BLACK |  RADIAN BROWN |  RADIAN GREY |  FLAT DARK EARTH |  RADIAN OD GREEN |
|--|--|---|---|---|

COMPLETE UPPER CONFIGURATIONS

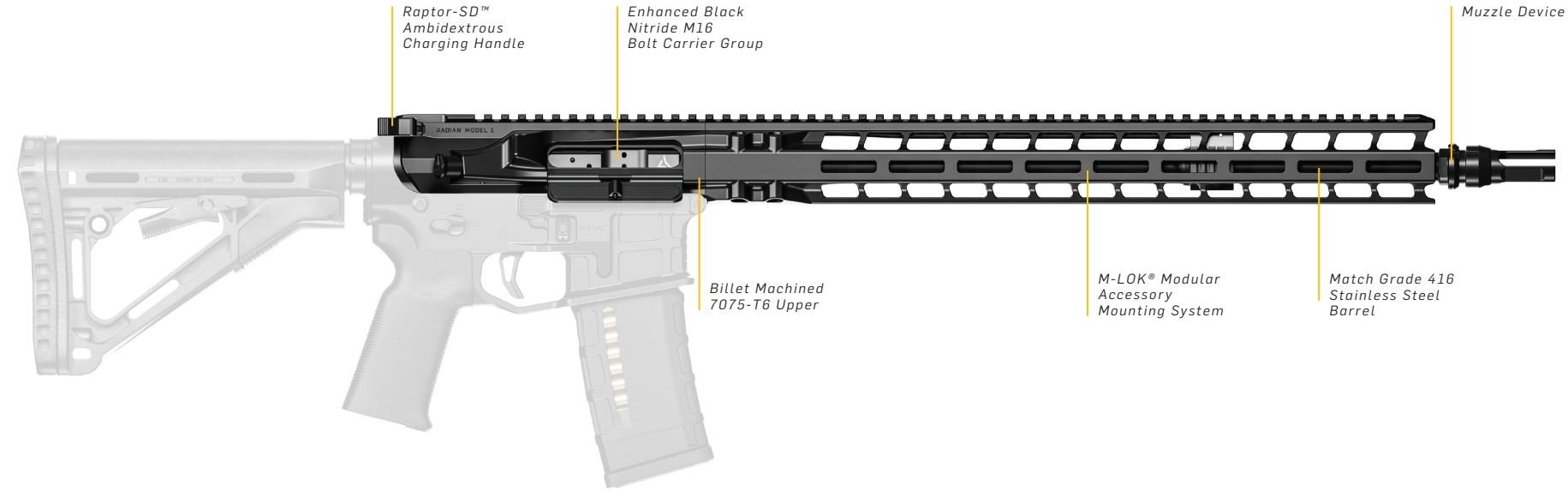



MODEL 1™ COMPLETE UPPER

SPECIFICATIONS

Sub-MOA Accuracy Guarantee w/ Black Hills Match Grade Ammunition
 Billet Machined 7075-T6 Upper Receiver w/ M4 Feed Ramps
 Proprietary Extended Aluminum Hand Guard w/ Magpul® M-LOK® Modular Mounting System and Integrated Upper/Hand Guard Hardened Steel Anti-Rotation Pin
 Match Grade 416R Stainless Steel Barrel w/ Polished Crown and Feed Ramps, Chambered in .223 Wylde/5.56 NATO or 300 BLK, Threaded 1/2 X 28 (.223) or 5/8 X 24 (300 BLK)

Black Nitride M16 Enhanced Bolt Carrier Group
 Ultra Lightweight 7075 Aluminum Forward Assist Assembly w/ Titanium Pawl
 Radian® Raptor-SD™ Ambidextrous Charging Handle
 Direct Impingement Gas System
 Flash Hider/Muzzle Brake Suppressor Mount

AVAILABLE COLORS:

- | | | | |
|---|--------------|---|-----------------|
|  | RADIAN BLACK |  | FLAT DARK EARTH |
|  | RADIAN BROWN |  | RADIAN OD GREEN |
|  | RADIAN GREY | | |



COMPLETE UPPER | 9"

- ▶ .300 Blackout
- ▶ 5/8x24 Thread Pitch
- ▶ Pistol-Length Gas System



COMPLETE UPPER | 10.5"

- ▶ .223 WYLDE
- ▶ 1/2x28 Thread Pitch
- ▶ Carbine-Length Gas System



COMPLETE UPPER | 14.5"

- ▶ .223 WYLDE
- ▶ 1/2 x28 Thread Pitch
- ▶ Mid-Length Gas System



COMPLETE UPPER | 16"

- ▶ .223 WYLDE
- ▶ 1/2 x28 Thread Pitch
- ▶ Mid-Length Gas System



COMPLETE UPPER | 17.5"

- ▶ .223 WYLDE
- ▶ 1/2 x28 Thread Pitch
- ▶ Intermediate-Length Gas System

MODEL 1™ BILLET UPPER & M-LOK® HAND GUARD

ABOUT

The Radian Model 1 Upper Receiver and Hand Guard are precision CNC machined as a matching set, structurally reinforced in critical areas for improved strength and rigidity. The upper receiver is cut from billet 7075-T6 aluminum and assembled with dust cover, hand guard anti-rotation pin, light weight forward assist, and Raptor-SD Ambidextrous Charging Handle. The hand guard features Magpul® M-LOK® accessory mounting slots that attach to the barrel nut using four steel cross bolts treated in black nitride for corrosion resistance. Every surface has been smoothed over and blended to ensure no uncomfortable, sharp edges can be found. The upper and hand guard are then sprayed with Radian Cerakote options for a perfectly matching finish.

INCLUDES

- 1 - Billet Upper Receiver w/ Dust Cover, Light Weight Forward Assist, & Hand Guard Anti-Rotation Pin
- 1 - Radian® Raptor-SD™ Ambidextrous Charging Handle
- 1 - Hand Guard w/ Magpul M-LOK Modular Attachment Interface
- 1 - 7075-T6 Aluminum Barrel Nut
- 1 - Barrel Nut Wrench
- 4 - Hand Guard Cross Bolts, Washers & Nuts

AVAILABLE COLORS:

- | | | | |
|---|--------------|---|-----------------|
|  | RADIAN BLACK |  | FLAT DARK EARTH |
|  | RADIAN BROWN |  | RADIAN OD GREEN |
|  | RADIAN GREY | | |

CONFIGURATIONS

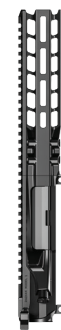

UPPER / HAND GUARD SET | 8.5"



UPPER / HAND GUARD SET | 10"



UPPER / HAND GUARD SET | 14"

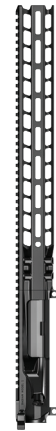

UPPER / HAND GUARD SET | 15.5"



UPPER / HAND GUARD SET | 17"



ADAC-15™ LOWER RECEIVER

Machined from billet 7075-T6 aluminum, the ADAC-15 is a fully ambidextrous lower receiver for AR15-style firearms. In addition to the Talon Ambidextrous Safety Selector, left-side magazine release, and right-side bolt release, the ADAC-15 features the patented A-DAC (Ambidextrous Dual Action Catch), which allows right-handed shooters to easily lock the bolt to the rear without taking their hand off fire control. To hold the bolt back using the A-DAC, simply pull the charging handle to the rear, depress the right-side magazine release button, then release the charging handle.

PRODUCT FEATURES

Billet machined 7075-T6 aluminum construction w/ integral trigger guard and flared magazine well

SART (Self-Adjusting Receiver Tensioner) spring-loaded plunger to reduce upper/lower wobble

Radian® Talon™ 45°/90° Ambidextrous Safety Selectors (long/short)

Enhanced Takedown Pin Set

All proprietary hardware included (extended bolt catch, left-side magazine release paddle, right-side magazine release button, right-side bolt release paddle, anti rotation hammer pin)

AVAILABLE COLORS:

- | | | | |
|---|--------------|---|-----------------|
|  | RADIAN BLACK |  | FLAT DARK EARTH |
|  | RADIAN BROWN |  | RADIAN OD GREEN |
|  | RADIAN GREY | | |

PARTS & ACCESSORIES



RAPTOR™ CHARGING HANDLES



RAPTOR™ AMBI CHARGING HANDLE

AR15/M16

For nearly a decade, the patented Raptor has been continuously refined into what is now the gold standard for ambidextrous charging handles. Its robust construction allows rapid palm "blading" or finger-thumb charging of the weapon, ensuring the motion is fluid and fast from either strong or support side. Made in the USA from aircraft grade 7075 aluminum and milspec anodized.

FEATURES

- ★ MOST POPULAR
- ☒ COLOR OPTIONS



RAPTOR™ AMBI CHARGING HANDLE

AR10/SR25

For nearly a decade, the patented Raptor has been continuously refined into what is now the gold standard for ambidextrous charging handles. Its robust construction allows rapid palm "blading" or finger-thumb charging of the weapon, ensuring the motion is fluid and fast from either strong or support side. Made in the USA from aircraft grade 7075 aluminum and milspec anodized.

FEATURES

- ★ MOST POPULAR



COMPETITION RAPTOR™ AMBI CHARGING HANDLE

AR15/M16

Based on the proven Raptor, the Competition Series lineup features Red anodized handles for shooters looking to add some extra flare to their builds. From rapid palm "blading" or finger-thumb charges for the weapon, the motion is fluid and fast from either strong or support side. Made in the USA from aircraft grade 7075 aluminum and milspec anodized.

FEATURES

- ☒ COMPETITION



RAPTOR-SD™ AMBI CHARGING HANDLE

AR15/M16

Utilizing the same proven construction as the original Raptor, the suppressor-optimized Raptor-SD features a ported shaft designed to redirect gasses down and forward, away from the shooter's face when shooting suppressed. Made in the USA from aircraft grade 7075 aluminum and milspec anodized.

FEATURES

- ☒ SILENCER OPTIMIZED
- ☒ COLOR OPTIONS



RAPTOR-SD™ AMBI CHARGING HANDLE

AR10/SR25

Utilizing the same proven construction as the original Raptor, the suppressor-optimized Raptor-SD features a ported shaft designed to redirect gasses down and forward, away from the shooter's face when shooting suppressed. Made in the USA from aircraft grade 7075 aluminum and milspec anodized.

FEATURES

- ☒ SILENCER OPTIMIZED



RAPTOR-SL™ AMBI CHARGING HANDLE

AR15/M16

Based on the proven Raptor™ Ambidextrous Charging Handle, the Raptor-SL™ features slim-line handles for customers who require an ultra low-profile, anti-snag design. From rapid palm "blading" or finger thumb charges for the weapon, the motion is fluid and fast from either strong or support side. Made in the USA from aircraft grade 7075 aluminum and milspec anodized.

FEATURES

- ☒ LOW PROFILE



RAPTOR SD-SL™ AMBI CHARGING HANDLE

AR15/M16

The Raptor™ SD-SL features slim-line handles and suppressor-optimized ported shaft for customers who require both an ultra low handle profile and gas redirecting capability while shooting suppressed. Its ambidextrous design allows rapid palm "blading" or finger-thumb charging of the weapons, ensuring the motion is fluid and fast from either strong or support side. Made in the USA from aircraft grade 7075 aluminum and milspec anodized.

FEATURES

- ☒ SILENCER OPTIMIZED
- ☒ LOW PROFILE



Subscribe to our newsletter at radianweapons.com to be the first to hear about limited edition product releases.

Image Shown: Limited Edition 4th of July Raptor™

RAPTOR™ CHARGING HANDLES



RAPTOR-LT™ AMBI CHARGING HANDLE

AR15/M16

The patented Raptor-LT charging handle provides added durability and function compared to the standard MIL-SPEC variant. Its ambidextrous design allows rapid palm "blading" or finger-thumb charging of the weapon, ensuring the motion is fluid and fast from either strong or support side. The Raptor-LT handles feature machined 7075 aluminum cores over-molded with high-strength, fiberglass reinforced polymer.

FEATURES

- ✦ LIGHTWEIGHT
- ☑ COLOR OPTIONS



RAPTOR-LT™ AMBI CHARGING HANDLE

AR10/SR25

The patented Raptor-LT charging handle provides added durability and function compared to the standard MIL-SPEC variant. Its ambidextrous design allows rapid palm "blading" or finger-thumb charging of the weapon, ensuring the motion is fluid and fast from either strong or support side. The Raptor-LT handles feature machined 7075 aluminum cores over-molded with high-strength, fiberglass reinforced polymer.

FEATURES

- ✦ LIGHTWEIGHT



RAPTOR-LT™ AMBI CHARGING HANDLE FOR SIG® MPX™

PLATFORM SPECIFIC

Introducing the Raptor-LT™ Ambidextrous Charging Handle for SIG® MPX™. The patented Raptor provides improved ergonomics and functionality compared to the factory variants. Its ambidextrous design allows rapid palm "blading" or finger-thumb charging of the weapon, ensuring the motion is fluid and fast from either strong or support side. The Raptor-LT handles feature machined 7075 aluminum cores over-molded with high-strength, fiberglass reinforced polymer.

FEATURES

- ✦ LIGHTWEIGHT



RAPTOR-LT™ AMBI CHARGING HANDLE FOR SIG® MCX™

PLATFORM SPECIFIC

Introducing the Raptor-LT™ Ambidextrous Charging Handle for SIG® MCX™. The patented Raptor provides improved ergonomics and functionality compared to the factory variants. Its ambidextrous design allows rapid palm "blading" or finger-thumb charging of the weapon, ensuring the motion is fluid and fast from either strong or support side. The Raptor-LT handles feature machined 7075 aluminum cores over-molded with high-strength, fiberglass reinforced polymer.

FEATURES

- ✦ LIGHTWEIGHT

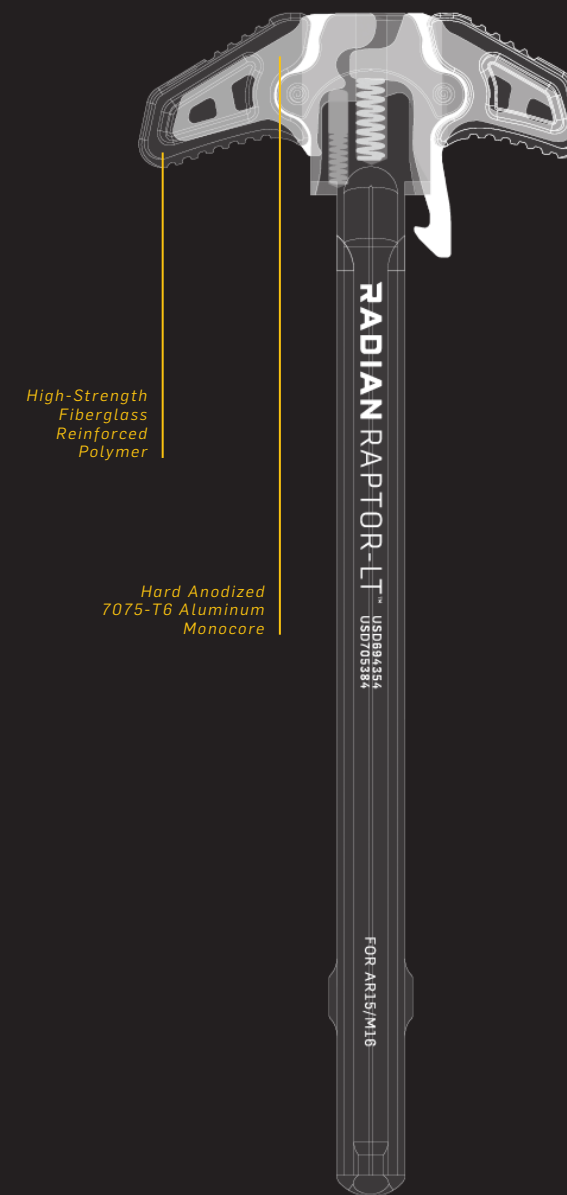

RAPTOR-LT™ AMBI CHARGING HANDLES

Utilizing the same patented ambidextrous functionality as its predecessor, the Raptor-LT handles are machined from 7075 aluminum, MILSPEC Type III hard anodized, then over-molded with high-strength, fiberglass reinforced polymer for the ultimate combination of strength, weight, and durability. The Raptor-LT is available in black, flat dark earth, and stealth grey, all designed to match standard Magpul® color offerings. Like all Radian products, the Raptor-LT comes with a limited lifetime warranty, and is 100% designed and manufactured in the USA.

COMPATIBILITY

The Raptor-LT is compatible with most AR15/M16-pattern rifles or AR10/25 pattern rifles. Options for Sig® MPX™ or MCX™ are available as standalone products. For more detailed compatibility information, please visit radianweapons.com

TALON™ SAFETY SELECTORS



ABOUT

The patented Talon ambidextrous safety selector is a modular design that can be installed as a standard 90° or as a 45° short throw by simply rotating the shaft 180° inside the lower receiver. Selector levers install using a precision machined dovetail interface with spring-loaded retention stud to lock the lever in place – no screws to come loose or break.

FEATURES

Compatible with Semi-Auto AR15 & AR10/SR25 Rifles and Sig Sauer® MPX™/MCX™





Levers Machined from Billet Aircraft Grade Aluminum

MIL-SPEC Type III Hard Coat Anodized Finish or Cerakote

Center Shaft Machined from Hardened Steel w/ Black Nitride Finish

Selector Detent, Detent Spring, and Mounting Hardware Included

AVAILABLE COLORS*

-  RADIANT BLACK
-  RADIANT GREY
-  FLAT DARK EARTH
-  RADIANT OD GREEN

**Colors not available for Talon™ Full Auto or Competition products*

RIFLE PARTS



ENHANCED BOLT CARRIER GROUP

The Enhanced Bolt Carrier Group for AR15/ M16 platform weapons was designed to minimize carrier tilt and reduce friction inside the upper receiver by relocating key bearing surfaces. All materials, tolerances, and coatings meet or exceed milspec standards for performance, reliability, and durability.

SPECIFICATIONS

Type: 223/5.56 NATO AR15/M16 (Full Auto) Bolt: Case Hardened 9310 Steel, Shot Peened w/ Black Nitride Finish Carrier: Billet Machined Case Hardened 8620 Steel w/ Black Nitride Finish Gas Key: 4130 Steel, Attached Using Grade 8 Hardware and Proper Staking Techniques Weight: 11.4 oz



VERTEX™ & VERTEX-FB™ SINGLE STAGE TRIGGER

The Radian Vertex & Vertex-FB Trigger were conceived with functional ergonomics at the center of the design philosophy. The trigger bow is positioned forward of the traditional bow location, enhancing the shooter's ability to make a straight-back trigger break, and reducing potential for "left and down" or "right and down" trigger pull.

The single stage Vertex & Vertex-FB Trigger feature a crisp, 3.5-4 pound break and short reset. The Vertex Trigger's bow is constructed from 1144 carbon steel, and the hammer from precision machined S7 shock resistant tool steel. The hammer is then wire-EDM finished in the interface areas. The components are captured in a lightweight aluminum housing. The Vertex Trigger is compatible with the AR15 platform, its design prevents pin walkout even when using standard hammer and trigger pins.



TALON™ 45°/90° AMBI SAFETY SELECTOR

2-LEVER KIT

FEATURES

☞ COLOR OPTIONS



TALON™ 45°/90° AMBI SAFETY SELECTOR

4-LEVER KIT

FEATURES

☞ COLOR OPTIONS



COMPETITION TALON™ 45°/90° AMBI SAFETY SELECTOR

2-LEVER KIT

FEATURES

☞ COMPETITION



TALON™ FULL AUTO AMBI SAFETY SELECTOR

2-LEVER KIT



TALON-G1™ NON AMBI SAFETY SELECTOR

SINGLE LEVER

FEATURES

☞ COLOR OPTIONS



TAKE DOWN PINS

AR15/M16



FORWARD ASSIST

7075 ALUMINUM
BLACK



ULTRALIGHT QD ENDPLATE

ALUMINUM + TITANIUM
BLACK



EXTENDED BOLT CATCH

THE RIFLE EVOLVED™

MODEL 1™ & MODEL 1™ CALIFORNIA COMPLIANT

9" PISTOL			
SKU	UPC	COLOR	CALIBER
R0052	817093027742	RADIAN BLACK	.300 BLK
R0053	817093027759	RADIAN GREY	.300 BLK
R0054	817093027766	RADIAN BROWN	.300 BLK
R0504	817093027773	FLAT DARK EARTH	.300 BLK
R0505	817093027780	RADIAN OD GREEN	.300 BLK

9" SBR			
SKU	UPC	COLOR	CALIBER
R0049	817093027827	RADIAN BLACK	.300 BLK
R0050	817093027834	RADIAN GREY	.300 BLK
R0051	817093027841	RADIAN BROWN	.300 BLK
R0499	817093027858	FLAT DARK EARTH	.300 BLK
R0500	817093027865	RADIAN OD GREEN	.300 BLK

10.5" PISTOL			
SKU	UPC	COLOR	CALIBER
R0033	817093027902	RADIAN BLACK	.223 WYLDE
R0034	817093027919	RADIAN GREY	.223 WYLDE
R0036	817093027926	RADIAN BROWN	.223 WYLDE
R0514	817093027933	FLAT DARK EARTH	.223 WYLDE
R0515	817093027940	RADIAN OD GREEN	.223 WYLDE

10.5" SBR			
SKU	UPC	COLOR	CALIBER
R0029	817093027988	RADIAN BLACK	.223 WYLDE
R0031	817093027995	RADIAN GREY	.223 WYLDE
R0032	817093028008	RADIAN BROWN	.223 WYLDE
R0509	817093028015	FLAT DARK EARTH	.223 WYLDE
R0510	817093028022	RADIAN OD GREEN	.223 WYLDE

14.5" RIFLE			
SKU	UPC	COLOR	CALIBER
R0037	817093028220	RADIAN BLACK	.223 WYLDE
R0038	817093028237	RADIAN GREY	.223 WYLDE
R0040	817093028244	RADIAN BROWN	.223 WYLDE
R0535	817093028251	FLAT DARK EARTH	.223 WYLDE
R0536	817093028268	RADIAN OD GREEN	.223 WYLDE

16" RIFLE			
SKU	UPC	COLOR	CALIBER
R0041	817093028305	RADIAN BLACK	.223 WYLDE
R0042	817093028312	RADIAN GREY	.223 WYLDE
R0044	817093028329	RADIAN BROWN	.223 WYLDE
R0540	817093028336	FLAT DARK EARTH	.223 WYLDE
R0541	817093028343	RADIAN OD GREEN	.223 WYLDE

THE RIFLE EVOLVED™

MODEL 1™ & MODEL 1™ CALIFORNIA COMPLIANT

17.5" RIFLE			
SKU	UPC	COLOR	CALIBER
R0045	817093028381	RADIAN BLACK	.223 WYLDE
R0046	817093028398	RADIAN GREY	.223 WYLDE
R0048	817093028404	RADIAN BROWN	.223 WYLDE
R0545	817093028411	FLAT DARK EARTH	.223 WYLDE
R0546	817093028428	RADIAN OD GREEN	.223 WYLDE

16" RIFLE (CALIFORNIA COMPLIANT)			
SKU	UPC	COLOR	CALIBER
R0259	817093028954	RADIAN BLACK	.223 WYLDE
R0260	817093028961	RADIAN GREY	.223 WYLDE
R0261	817093028978	RADIAN BROWN	.223 WYLDE
R0601	817093028985	FLAT DARK EARTH	.223 WYLDE
R0602	817093028992	RADIAN OD GREEN	.223 WYLDE

14.5" RIFLE (CALIFORNIA COMPLIANT)			
SKU	UPC	COLOR	CALIBER
R0262	817093028848	RADIAN BLACK	.223 WYLDE
R0263	817093028855	RADIAN GREY	.223 WYLDE
R0264	817093028862	RADIAN BROWN	.223 WYLDE
R0596	817093028879	FLAT DARK EARTH	.223 WYLDE
R0597	817093028886	RADIAN OD GREEN	.223 WYLDE

17.5" RIFLE (CALIFORNIA COMPLIANT)			
SKU	UPC	COLOR	CALIBER
R0265	817093029036	RADIAN BLACK	.223 WYLDE
R0266	817093029043	RADIAN GREY	.223 WYLDE
R0267	817093029050	RADIAN BROWN	.223 WYLDE
R0606	817093029067	FLAT DARK EARTH	.223 WYLDE
R0607	817093029074	RADIAN OD GREEN	.223 WYLDE

RECEIVERS

MODEL 1" BUILDER KIT

8.5"		
SKU	UPC	COLOR
R0435	817093024185	RADIAN BLACK
R0436	817093025663	RADIAN GREY
R0437	817093025595	RADIAN BROWN
R0438	817093025564	FLAT DARK EARTH
R0439	817093025564	RADIAN OD GREEN

14"		
SKU	UPC	COLOR
R0411	817093027087	RADIAN BLACK
R0412	817093027070	RADIAN GREY
R0413	817093027063	RADIAN BROWN
R0414	817093027056	FLAT DARK EARTH
R0415	817093027049	RADIAN OD GREEN

17"		
SKU	UPC	COLOR
R0395	817093023782	RADIAN BLACK
R0396	817093023799	RADIAN GREY
R0397	817093023805	RADIAN BROWN
R0398	817093023812	FLAT DARK EARTH
R0399	817093022570	RADIAN OD GREEN

10"		
SKU	UPC	COLOR
R0427	817093026875	RADIAN BLACK
R0428	817093026868	RADIAN GREY
R0429	817093026851	RADIAN BROWN
R0430	817093026844	FLAT DARK EARTH
R0431	817093025731	RADIAN OD GREEN

15.5"		
SKU	UPC	COLOR
R0403	817093022532	RADIAN BLACK
R0404	817093022624	RADIAN GREY
R0405	817093022617	RADIAN BROWN
R0406	817093022600	FLAT DARK EARTH
R0407	817093022594	RADIAN OD GREEN

RECEIVERS

MODEL 1" COMPLETE UPPER

9"			
SKU	UPC	COLOR	CALIBER
R0027	817093027728	RADIAN BLACK	.300 BLK
R0443	817093024260	RADIAN GREY	.300 BLK
R0444	817093024277	RADIAN BROWN	.300 BLK
R0445	817093024284	FLAT DARK EARTH	.300 BLK
R0446	817093024291	RADIAN OD GREEN	.300 BLK

14.5"			
SKU	UPC	COLOR	CALIBER
R0024	817093020828	RADIAN BLACK	.223 WYLDE
R0464	817093024475	RADIAN GREY	.223 WYLDE
R0465	817093024482	RADIAN BROWN	.223 WYLDE
R0466	817093024499	FLAT DARK EARTH	.223 WYLDE
R0467	817093024505	RADIAN OD GREEN	.223 WYLDE

17.5"			
SKU	UPC	COLOR	CALIBER
R0026	817093020842	RADIAN BLACK	.223 WYLDE
R0478	817093024611	RADIAN GREY	.223 WYLDE
R0479	817093024628	RADIAN BROWN	.223 WYLDE
R0480	817093024635	FLAT DARK EARTH	.223 WYLDE
R0481	817093024642	RADIAN OD GREEN	.223 WYLDE

10.5"			
SKU	UPC	COLOR	CALIBER
R0023	817093020811	RADIAN BLACK	.223 WYLDE
R0450	817093024338	RADIAN GREY	.223 WYLDE
R0451	817093024345	RADIAN BROWN	.223 WYLDE
R0452	817093024352	FLAT DARK EARTH	.223 WYLDE
R0453	817093024369	RADIAN OD GREEN	.223 WYLDE

16"			
SKU	UPC	COLOR	CALIBER
R0025	817093020835	RADIAN BLACK	.223 WYLDE
R0471	817093024543	RADIAN GREY	.223 WYLDE
R0472	817093024550	RADIAN BROWN	.223 WYLDE
R0473	817093024567	FLAT DARK EARTH	.223 WYLDE
R0474	817093024574	RADIAN OD GREEN	.223 WYLDE

RECEIVERS

MODEL 1" BILLET UPPER/HAND GUARD COMBO &
ADAC-15" LOWER RECEIVER

8.5"		
SKU	UPC	COLOR
R0196	817093021375	RADIAN BLACK
R0646	817093024192	RADIAN GREY
R0647	817093024208	RADIAN BROWN
R0648	817093024215	FLAT DARK EARTH
R0649	817093024222	RADIAN OD GREEN

14"		
SKU	UPC	COLOR
R0194	817093021351	RADIAN BLACK
R0624	817093023959	RADIAN GREY
R0626	817093023966	RADIAN BROWN
R0627	817093023973	FLAT DARK EARTH
R0628	817093023980	RADIAN OD GREEN

17"		
SKU	UPC	COLOR
R0192	817093026349	RADIAN BLACK
R0611	817093025915	RADIAN GREY
R0612	817093025922	RADIAN BROWN
R0613	817093025939	FLAT DARK EARTH
R0614	817093023829	RADIAN OD GREEN

10"		
SKU	UPC	COLOR
R0195	817093024109	RADIAN BLACK
R0639	817093024116	RADIAN GREY
R0640	817093024123	RADIAN BROWN
R0641	817093024130	FLAT DARK EARTH
R0642	817093024147	RADIAN OD GREEN

15.5"		
SKU	UPC	COLOR
R0193	817093023867	RADIAN BLACK
R0618	817093023874	RADIAN GREY
R0619	817093023881	RADIAN BROWN
R0620	817093023898	FLAT DARK EARTH
R0621	817093023904	RADIAN OD GREEN

ADAC-15" LOWER RECEIVER		
SKU	UPC	COLOR
R0166	817093021153	RADIAN BLACK
R0388	817093023720	RADIAN GREY
R0389	817093023737	RADIAN BROWN
R0390	817093023713	FLAT DARK EARTH
R0391	817093023744	RADIAN OD GREEN

RIFLE PARTS & ACCESSORIES

RAPTOR™ AMBIDEXTROUS CHARGING HANDLES

RAPTOR™			
SKU	UPC	COLOR	TYPE
R0001	817093020477	BLACK ANODIZED	AR15/M16
R0003	817093020521	FLAT DARK EARTH	AR15/M16
R0560	817093022877	RADIAN GREY	AR15/M16
R0375	817093023584	RADIAN OD GREEN	AR15/M16
R0005	817093020552	NP3 COATED	AR15/M16
R0232	817093021993	COMPETITION RED	AR15/M16
R0007	817093020484	BLACK ANODIZED	AR10/SR25

RAPTOR™ & TALON™ 45°/90° COMBO			
SKU	UPC	COLOR	TYPE
R0275	817093022037	BLACK ANODIZED	AR15/M16
R0299	817093022792	FLAT DARK EARTH	AR15/M16
R0664	817093027520	RADIAN GREY	AR15/M16
R0665	817093027537	RADIAN OD GREEN	AR15/M16

RAPTOR-SD™			
SKU	UPC	COLOR	TYPE
R0006	817093020491	BLACK ANODIZED	AR15/M16
R0066	817093020705	FLAT DARK EARTH	AR15/M16
R0561	817093025441	RADIAN GREY	AR15/M16
R0376	817093023591	RADIAN OD GREEN	AR15/M16
R0012	817093020507	BLACK ANODIZED	AR10/SR25

RAPTOR-SL™			
SKU	UPC	COLOR	TYPE
R0176	817093021900	BLACK ANODIZED	AR15/M16

RAPTOR SD-SL™			
SKU	UPC	COLOR	TYPE
R0278	817093022112	BLACK ANODIZED	AR15/M16

RAPTOR-LT™			
SKU	UPC	COLOR	TYPE
R0148	817093021160	BLACK ANODIZED	AR15/M16
R0149	817093021177	FLAT DARK EARTH	AR15/M16
R0150	817093021184	STEALTH GREY	AR15/M16
R0151	817093021191	BLACK ANODIZED	AR10/SR25
R0364	817093023478	BLACK ANODIZED	SIG® MCX™
R0367	817093023508	BLACK ANODIZED	SIG® MPX™

RAPTOR-LT™ & TALON™ 45°/90° COMBO			
SKU	UPC	COLOR	TYPE
R0290	817093022310	BLACK ANODIZED	AR15/M16

RIFLE PARTS & ACCESSORIES

TALON™ 45°/90° SAFETY SELECTOR & RIFLE ACCESSORIES

TALON™ 45°/90° 2 LEVER KIT		
SKU	UPC	COLOR
R0018	817093020514	BLACK ANODIZED
R0020	817093020668	FLAT DARK EARTH
R0567	817093025502	RADIAN GREY
R0381	817093023645	RADIAN OD GREEN
R0233	817093022006	COMPETITION RED

TALON-G1™ 45°/90°		
SKU	UPC	COLOR
R0294	817093022198	BLACK ANODIZED
R0293	817093022631	RADIAN GREY
R0592	817093025755	FLAT DARK EARTH
R0383	817093023676	RADIAN OD GREEN

TALON™ 45°/90° 4 LEVER KIT		
SKU	UPC	COLOR
R0013	817093020606	BLACK ANODIZED
R0015	817093020613	RADIAN GREY
R0566	817093025496	FLAT DARK EARTH
R0382	817093023652	RADIAN OD GREEN

TALON™ FULL AUTO		
SKU	UPC	COLOR
R0363	817093023461	BLACK ANODIZED

ACCESSORIES		
SKU	UPC	COLOR
R0231	817093021733	FORWARD ASSIST - 7075 ALUMINUM
R0077	817093020767	TAKEDOWN PIN KIT - AR15
R0078	817093020774	QD END PLATE ALUMINUM + TITANIUM
R0081	817093027377	ENHANCED BCG 5.56 NATO
R0692	817093027391	ENHANCED BCG 6.5 SPC
R0323	817093022839	EXTENDED BOLT CATCH

VERTEX™ TRIGGER			
SKU	UPC	TYPE	COLOR
ACC-0016	817093027407	VERTEX™	BLACK
ACC-0017	817093027414	VERTEX-FB™	BLACK

THE PISTOL EVOLVED™

PISTOL PRODUCTS

GUARDIAN™ + SIX™		
SKU	UPC	TYPE
A-G-19-ROD	810098420006	COMPRESSOR QUICK-TUNE™ GUIDE ROD
G1001	810098420105	GLOCK® MOS - RMR GUARDIAN™
G1002	810098420112	GLOCK® MOS - EPS GUARDIAN™
G2001	810098420129	WALTHER PDP 2.0 - RMR GUARDIAN™
G2002	810098420136	WALTHER PDP 2.0 - EPS GUARDIAN™
H0001	810098420334	GLOCK® MOS - HS 407/507 GUARDIAN™
H0013	810098420471	WALTHER PDP 2.0 - HS 407/507 GUARDIAN™
G1501	810098420143	GLOCK® MOS - RMR GUARDIAN™ + SIX™
G1502	810098420150	GLOCK® MOS - EPS GUARDIAN™ + SIX™
H0002	810098420341	GLOCK® MOS - HS 407/507 GUARDIAN™ + SIX™
G2501	810098420167	WALTHER PDP 2.0 - RMR GUARDIAN™ + SIX™
G2502	810098420174	WALTHER PDP 2.0 - EPS GUARDIAN™ + SIX™
H0012	810098420488	WALTHER PDP 2.0 - HS 407/507 GUARDIAN™ + SIX™
G9001	810098420181	GLOCK® MOS - RMR SIX™ BACK-UP SIGHTS
G9002	810098420198	GLOCK® MOS - EPS SIX™ BACK-UP SIGHTS
G9003	810098420204	WALTHER PDP 2.0 - RMR SIX™ BACK-UP SIGHTS
G9004	810098420211	WALTHER PDP 2.0 - EPS SIX™ BACK-UP SIGHTS

AFTERBURNER™ + RAMJET™		
SKU	UPC	TYPE
G19G3-IL-RN	817093028688	GLOCK® G19™ - GEN3 AFTERBURNER™ + RAMJET™
G19G4-IL-RN	817093028725	GLOCK® G19™ - GEN4 AFTERBURNER™ + RAMJET™
G19G5-IL-RN	817093028664	GLOCK® G19™ - GEN5/G45/G19X AFTERBURNER™ + RAMJET™
H0005	810098420372	GLOCK® G17™ - GEN5/G45/G19X AFTERBURNER™ + RAMJET™

PISTOL ACCESSORIES		
SKU	UPC	TYPE
A-G-19-ROD	810098420006	COMPRESSOR QUICK-TUNE™ GUIDE ROD
H0014	810098420495	BACKSTRAP + MAGWELL X-MACRO GRIP MODULE



 **RADIAN**[®]

✉ SUPPORT@RADIANWEAPONS.COM ☎ 503.893.2987
875 NE KINGWOOD AVE | REDMOND, OR | 97756

COPYRIGHT © 2024 / RADIAN WEAPONS / ALL RIGHTS RESERVED